



aspenhome™

Parts Drawing and Bill of Materials

Replacement Part Number List

Item No. : I49-222 Expandable Console

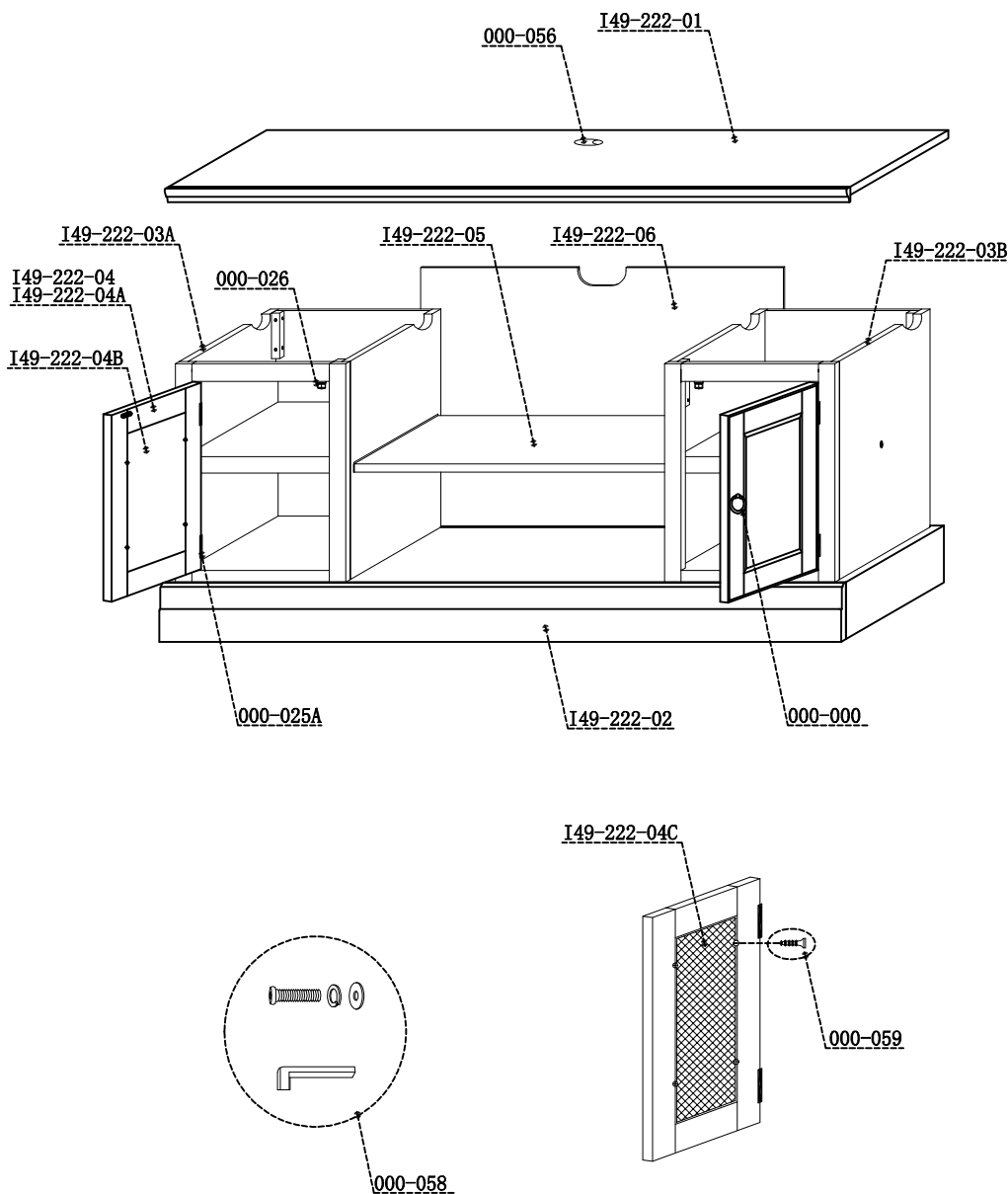

Distributed by
Furniture Values International, LLC 602-442-5600
Customer Service Fax 888-484-5874

Products shown in the catalog are representative of the products sold by Furniture Values International, LLC and may vary as to specific size, material, and finishes. Furniture Values International, LLC reserves the right to modify prices, dimensions, designs, materials, and finishes regarding these products anytime at its sole discretion. The information contained in the catalog is updated by the Company from time to time and may not accurately reflect products currently being produced.